

Katrin Soap Dispenser 500 ml

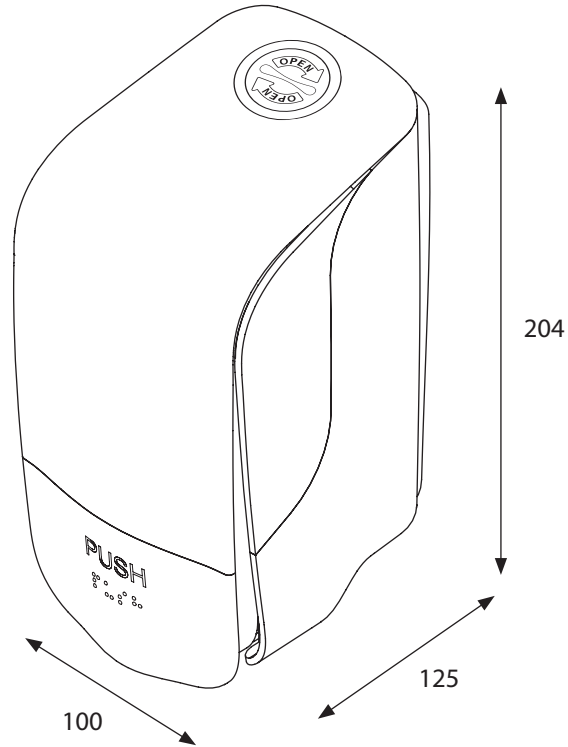

Click key out from the back plate

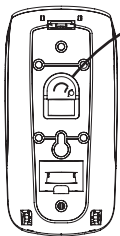

A. Open with key
(Position – key needed and turn right)

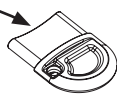

B. Easy opening
(Position – turn left with key once, then no key needed to open dispenser)

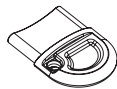

Click

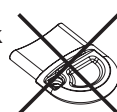

B. Push down on top of cover to open

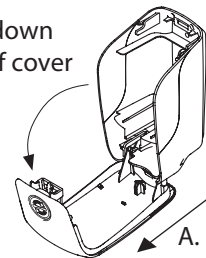

A. Pull lower part of cover outward

265

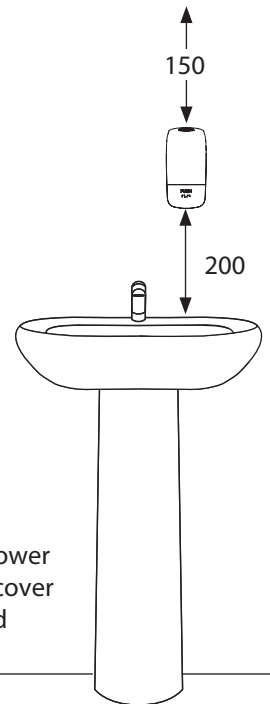

SCALE 1:1

